

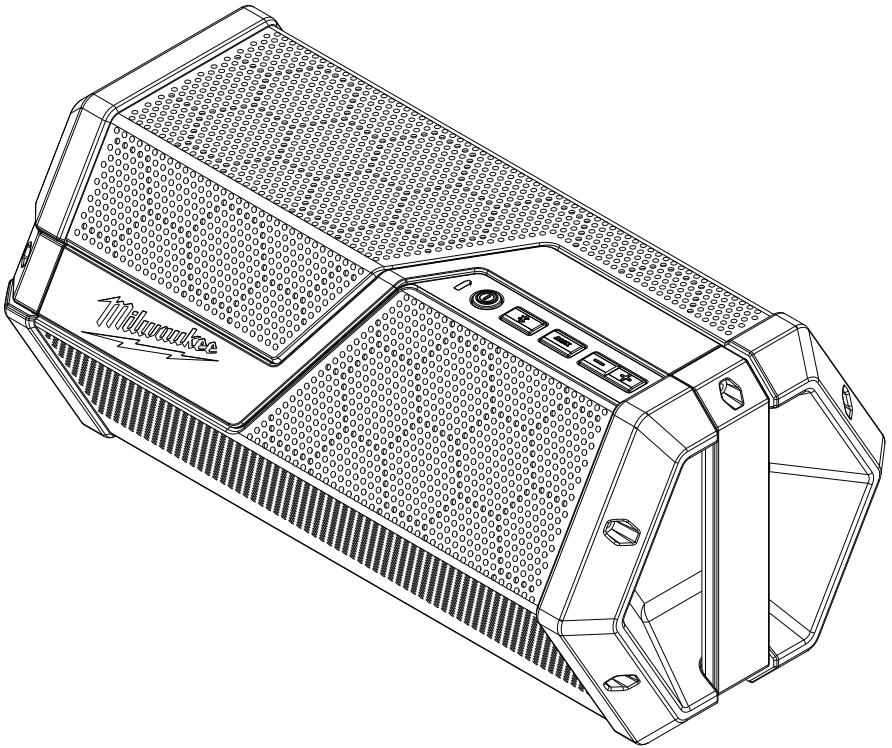

OPERATOR'S MANUAL



Cat. No.
M12-18 JSSP

M18™ / M12™ WIRELESS JOBSITE SPEAKER

 **WARNING**

To reduce the risk of injury, user must read and understand operator's manual.



IMPORTANT SAFETY INSTRUCTIONS

⚠WARNING Read, understand and follow all instructions. Failure to heed all warnings listed below, may result in electric shock, fire and/or serious personal injury. **Keep these instructions.**

- **Read these instructions.**
- **Keeps these instructions.**
- **Heed all warnings.**
- **Follow all instructions.**
- **Do not use this apparatus near water.** Never immerse the apparatus in liquid or allow a liquid to flow inside the apparatus. Water entering an apparatus will increase the risk for electric shock.
- **Clean only with dry cloth.** Certain cleaning agents and solvents are harmful to plastics and other insulated parts. Some of these include: gasoline, turpentine, lacquer thinner, paint thinner, chlorinated cleaning solvents, ammonia and household detergents containing ammonia. Clean dust and debris from vents. Keep the apparatus handle clean, dry and free of oil or grease.
- **Do not block any ventilation openings.** Install in accordance with the manufacturer's instructions.
- **Do not use near any heat sources** such as radiators, heat registers, stoves, or other apparatus (including amplifiers) that produce heat.
- **Use only attachments/accessories specified by the manufacturer.**
- **Only operate this apparatus in a well ventilated area.**
- **Refer all servicing to qualified service personnel.** Servicing is required when the apparatus has been damaged in any way, such as power-supply cord or plug is damaged, liquid has been spilled or objects have fallen into the apparatus, the apparatus has been exposed to rain or moisture or does not operate normally. Service or maintenance performed by unqualified personnel could result in a risk of injury.
- **A battery operated apparatus with integral batteries or a separate battery pack must be recharged only with the specified charger for the battery.** A charger that may be suitable for one type of battery may create a risk of fire when used with another battery.
- **Use battery operated apparatus only with specifically designated battery packs.** Use of any other batteries may create a risk of fire.
- **When battery pack is not in use, keep it away from other metal objects like: paper clips, coins, keys, nails, screws, or other small metal objects that can make a connection from one terminal to another.** Shorting the battery terminals together may cause sparks, burns, or a fire.
- **Avoid body contact with grounded surfaces such as pipes, radiators, ranges and refrigerators.** There is an increased risk of electric shock if your body is grounded.
- **Never disassemble the apparatus or try to do any rewiring on the apparatus's electrical system.**
- **Do not expose this apparatus to dripping and splashing, or place objects filled with liquids on this unit.**
- **Use only System M12/ M18 chargers for charging System M12/ M18 battery packs.** Do not use battery/packs from other systems.
- **Temperatures in excess of 50°C (122°F) reduce the performance of the battery pack.** Avoid extended exposure to heat or sunshine (risk of overheating).

SPECIFIC SAFETY RULES

- **Maintain labels and nameplates.** These carry important information. If unreadable or missing, contact a MILWAUKEE® service facility for a replacement.

• **This apparatus is designed to be powered by either an 18 volt or a 12 volt MILWAUKEE® Li-ion battery pack.** Do not attempt to use with any other voltage or power supply.

FC Federal Communications Commission









WARNING: Changes or modifications to this unit not expressly approved by the party responsible for compliance could void the user's authority to operate the equipment.

This device complies with Part 15 of the FCC Rules. Operation is subject to the following two conditions: (1) this device may not cause harmful interference, and (2) this device must accept any interference received, including interference that may cause undesired operation.

NOTE: This equipment has been tested and found to comply with the limits for a Class B digital device, pursuant to Part 15 of the FCC Rules. These limits are designed to provide reasonable protection against harmful interference in a residential installation. This equipment generates, uses and can radiate radio frequency energy and, if not installed and used in accordance with the instructions, may cause harmful interference to radio communications. However, there is no guarantee that interference will not occur in a particular installation. If this equipment does cause harmful interference to radio or television reception, which can be determined by turning the equipment off and on, the user is encouraged to try to correct the interference by one or more of the following measures:

- Reorient or relocate the receiving antenna.
- Increase the separation between the equipment and receiver.
- Connect the equipment into an outlet on a circuit different from that to which the receiver is connected.
- Consult the dealer or an experienced radio/TV technician for help.
- The transmitter must not be co-located or operated in conjunction with any other antenna or transmitter. This equipment complies with the FCC RF radiation exposure limits set forth for an uncontrolled environment. This equipment should be installed and operated with a minimum distance of 20 cm between the radiator and any part of your body.
- Similarly in Australia and New Zealand this product complies to ACMA EMC requirements.

SYMBOLGY

	Volts
	Direct Current
	Double Insulated
	Amps
	To reduce the risk of injury, user must read operator's manual.
	Regulatory Compliance mark (RCM). This product meets applicable regulatory requirements.
	Indoor Use Only
	Energy Efficiency

SPECIFICATIONS

Cat. No.	M12-18 JSSP
Volts	12/18 DC
Amps	2.6
Battery Type	M12™ and M18™
Charger Type	M12™ and M18™
USB Output Volts	5 DC
Max USB Output Amps	2.1
Recommended Ambient Operating Temperature	0°C to 52°C

FUNCTIONAL DESCRIPTION

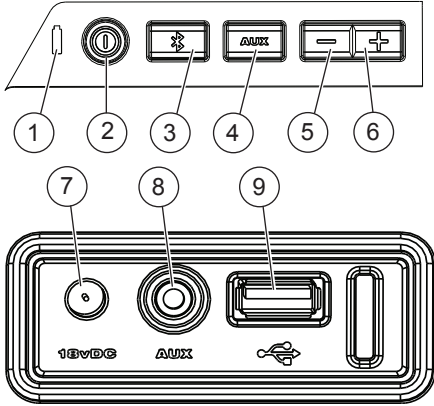

1. Low battery indicator
2. Power button
3. Bluetooth indicator button
4. Aux indicator button
5. Volume down
6. Volume up
7. AC/DC power supply jack
8. AUX jack
9. USB power outlet

EXTENSION CORDS

Grounded tools require a three wire extension cord. As the distance from the supply outlet increases, you must use a heavier gauge extension cord. Using extension cords with inadequately sized wire causes a serious drop in voltage, resulting in loss of power and possible tool damage.

Guidelines for Using Extension Cords

- If you are using an extension cord outdoors, be sure it is acceptable for outdoor use.
- Be sure your extension cord is properly wired and in good electrical condition. Always replace a damaged extension cord or have it repaired by a qualified person before using it.
- Protect your extension cords from sharp objects, excessive heat and damp or wet areas.

ASSEMBLY

WARNING Recharge only with the charger specified for the battery. For specific charging instructions, read the operator's manual supplied with your charger and battery.

Removing/Inserting the Battery

To remove the battery, push in the release buttons and pull the battery pack away from the tool.

WARNING Always remove battery pack before changing or removing accessories.

To insert the battery, slide the pack into the body of the tool. Make sure it latches securely into place.

WARNING Only use accessories specifically recommended for this tool. Others may be hazardous.

Low Battery Indicator

To protect the life of the battery pack, the low battery indicator will flash red when the battery's charge is low, but still operable. The indicator will light solid red when the battery's charge is inoperable. If this happens, remove the battery pack and charge it according to the charger's instructions.

Using the AC/DC Power Supply

Only use MILWAUKEE® 18 volt AC/DC power supply. Insert the power supply into the 18 volt DC jack on the back of the speaker. Plug the power supply into a suitable wall outlet.

Connecting an Auxiliary Device

Connect an MP3 player, CD player, or other audio device directly to the speaker using the stereo auxiliary jack AUX.

USB Power Outlet

This outlet can be used to charge a cell phone, power an MP3 player or any other device that uses less than 2.1A of DC electrical current.

NOTE: Any device that uses more than 2.1 A of DC electrical current will trip a self-resetting overload and disable the output.

OPERATION

WARNING To reduce the risk of fire or electric shock, do not expose this speaker to rain or moisture.

Turning On/Off and Connecting to Bluetooth

Press the Power button to turn the speaker on and off.

Press the Bluetooth button to turn the Bluetooth on. The speaker will begin to search for a previously paired device.

- If no Bluetooth device was previously paired, Bluetooth will enter standby mode. The indicator light will be solid.
- To pair the speaker to a new device, press and hold the Bluetooth button for 2 seconds until the indicator light flashes. It will then be in pair mode and can be connected to a different device.
- To pair a device to the speaker, select "M18/M12 Wireless Jobsite Speaker" on the Bluetooth capable device.
- Once paired, the speaker will automatically reconnect to the same device when the speaker is turned on.
- Once the device has successfully paired with the speaker, use the controls on the Bluetooth capable device to move through tracks and control volume.



Volume

Use the - and + buttons to decrease or increase the volume.

MAINTENANCE

⚠WARNING To reduce the risk of injury, always unplug the charger and remove the battery pack from the charger or tool before performing any maintenance. Never disassemble the tool, battery pack or charger. Contact a MILWAUKEE® service facility for ALL repairs.

Maintaining Tool

Keep your tool, battery pack and charger in good repair by adopting a regular maintenance program. Inspect your tool for issues such as undue noise, misalignment or binding of moving parts, breakage of parts, or any other condition that may affect the tool operation. Return the tool, battery pack, and charger to a MILWAUKEE® service facility for repair. After six months to one year, depending on use, return the tool, battery pack and charger to a MILWAUKEE® service facility for inspection.

If the tool does not start or operate at full power with a fully charged battery pack, clean the contacts on the battery pack. If the tool still does not work properly, return the tool, charger and battery pack, to a MILWAUKEE® service facility for repairs.

⚠WARNING To reduce the risk of personal injury and damage, never immerse your tool, battery pack or charger in liquid or allow a liquid to flow inside them.

Cleaning

Clean dust and debris from vents. Keep handles clean, dry and free of oil or grease. Use only mild soap and a damp cloth to clean, since certain cleaning agents and solvents are harmful to plastics and other insulated parts. Some of these include gasoline, turpentine, lacquer thinner, paint thinner, chlorinated cleaning solvents, ammonia and household detergents containing ammonia. Never use flammable or combustible solvents around tools.

Repairs

For repairs, return the tool, battery pack and charger to the nearest service centre.

ACCESSORIES

⚠WARNING Use only recommended accessories. Others may be hazardous.

For a complete listing of accessories refer to your MILWAUKEE® Tool catalog or go online to www.milwaukeetools.com.au/ [www.milwaukeetools.co.nz.](http://www.milwaukeetools.co.nz/) To obtain a catalog, contact your local distributor or a service centre.

WARRANTY - AUSTRALIA and NEW ZEALAND

Please refer to Australian and New Zealand warranty supplied with tool. This warranty applies only to product sold in Australia and New Zealand.

SERVICE - AUSTRALIA and NEW ZEALAND

MILWAUKEE® prides itself in producing a premium quality product that is Nothing But Heavy Duty®. Your satisfaction with our products is very important to us! If you encounter any problems with the operation of this tool, please contact your authorised MILWAUKEE® dealer.

For a list of MILWAUKEE® dealers, guarantee or service agents please contact MILWAUKEE® Customer Service or visit our website.

(Australia Toll Free Telephone Number 1300 645 928)

(New Zealand Toll Free Telephone Number 0800 279 624)

or visit www.milwaukeetools.com.au/ [www.milwaukeetools.co.nz.](http://www.milwaukeetools.co.nz/)

Milwaukee Electric Tool Corporation

13135 West Lisbon Road, Brookfield, Wisconsin U.S.A. 53005

Milwaukee Electric Tool Corporation (Australia)

Techtronic Industries (Australia) Pty. Ltd.
Rowville, Victoria, Australia, 3178

Milwaukee Electric Tool Corporation (New Zealand)

Techtronic Industries (New Zealand) Pty. Ltd.
Mangere, Auckland, New Zealand, 2022

Professionally made in China for Milwaukee Electric Tool Corporation